

NOTES:

1. Material : Music Wire
2. Finish : Glod Irridite
3. Ends : Closed and Ground
4. Total Coils : 16.000
5. Sugg. Max. Deflection : 1.600 (in)
6. Sugg. Max. Load : 139.000 (lbs)
7. All Drawing Dimensions are in Inches [mm]

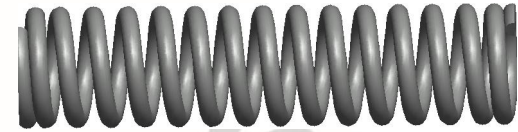

\varnothing 0.148
 [3,76]
 WIRE DIA

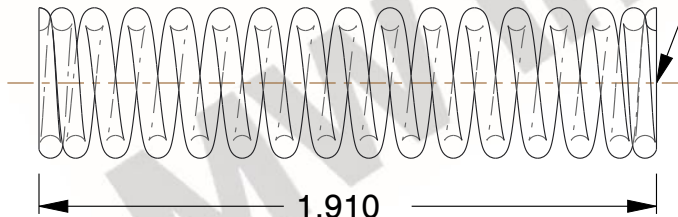

1.910
 [48,51]
 LENGTH

GROUND SURFACE

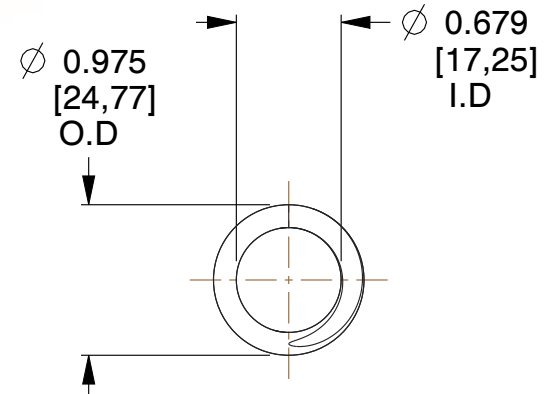

\varnothing 0.975
 [24,77]
 O.D

\varnothing 0.679
 [17,25]
 I.D

COMPONENT		SPRINGS	
72481 COMPRESSION SPRINGS		UNIT	INCH [mm]
		SHEET	1 of 1