

**NOTES:**

1. Material : Stainless Steel
2. Finish : Glod Irridite
3. Ends : Closed and Ground
4. Total Coils : 16.300
5. Sugg. Max. Deflection : 1.000 (in)
6. Sugg. Max. Load : 1.300 (lbs)
7. All Drawing Dimensions are in Inches [mm]

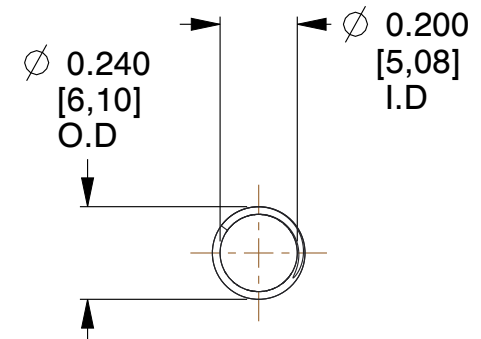
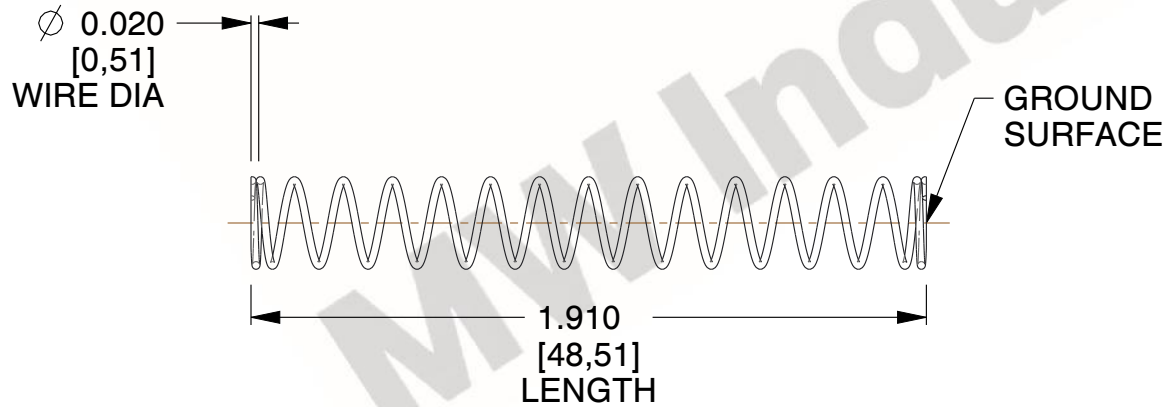

COMPONENT		SPRINGS	
<b>70575S</b>  COMPRESSION SPRINGS		UNIT	INCH [mm]
		SHEET	1 of 1