

**NOTES:**

1. Material : Spring Steel
2. Finish : Glod Irridite
3. Ends : Closed and Ground
4. Total Coils : 9.500
5. Sugg. Max. Deflection : 0.420 (in)
6. Sugg. Max. Load : 22.000 (lbs)
7. All Drawing Dimensions are in Inches [mm]

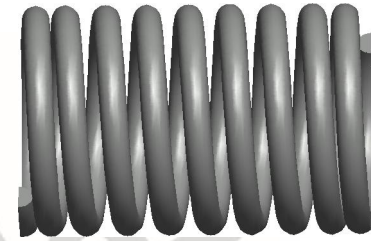

$\varnothing$  0.120  
 [3,05]  
 WIRE DIA

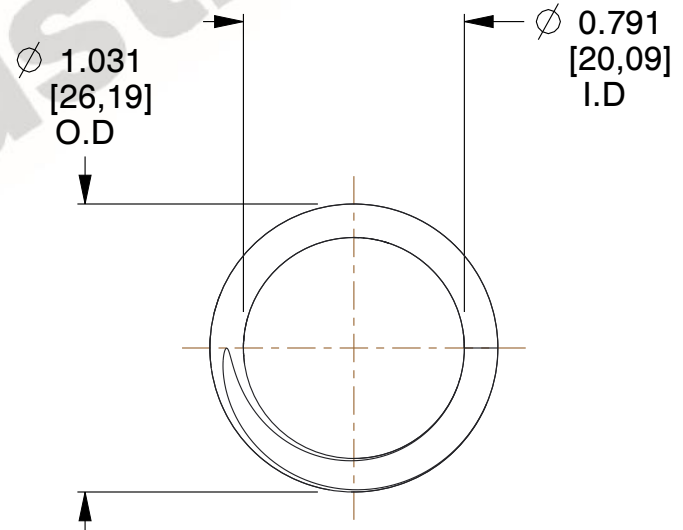
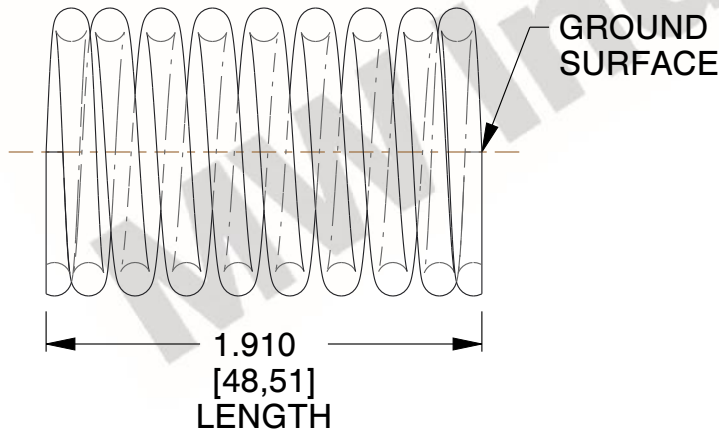

COMPONENT		SPRINGS	
<b>12447</b>  COMPRESSION SPRINGS		UNIT	INCH [mm]
		SHEET	1 of 1