

NOTES:

1. Material : Hard Drawn
2. Finish : Zinc - Z
3. Ends : Closed and Ground
4. Total Coils : 24.000
5. Sugg. Max. Deflection : 2.000 (in)
6. Sugg. Max. Load : 3.900 (lbs)
7. All Drawing Dimensions are in Inches [mm]

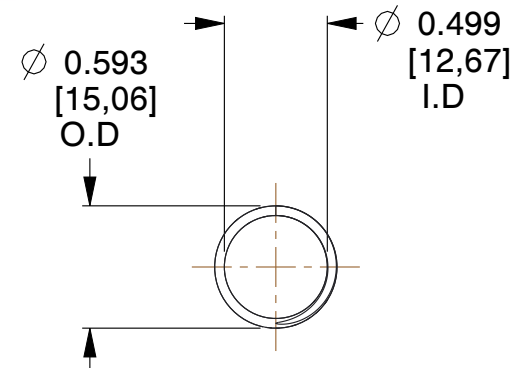
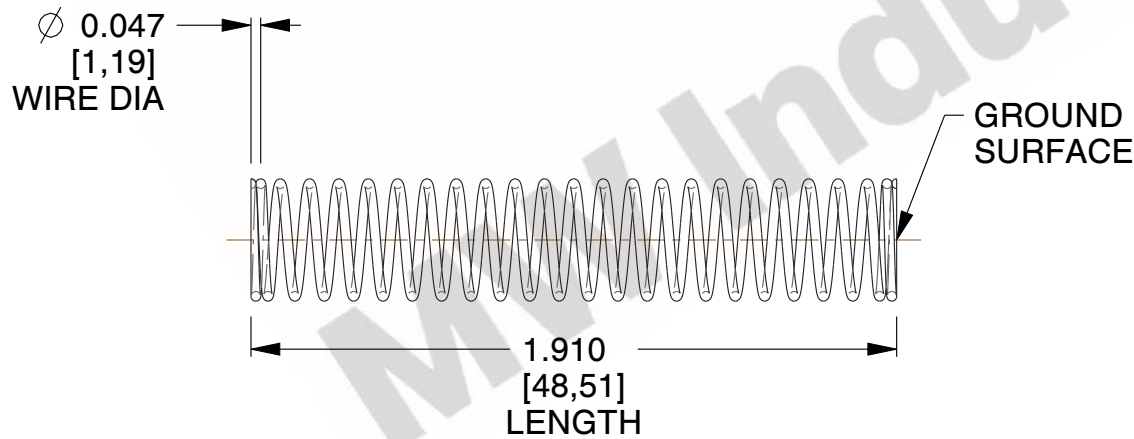

COMPONENT		SPRINGS	
2772		UNIT	
		INCH [mm]	
		SHEET	
COMPRESSION SPRINGS		1 of 1	