

NOTES:

1. Material : Music Wire
2. Finish : Glod Irridite
3. Ends : Closed and Ground
4. Total Coils : 4.630
5. Sugg. Max. Deflection : 0.220 (in)
6. Sugg. Max. Load : 2.600 (lbs)
7. All Drawing Dimensions are in Inches [mm]

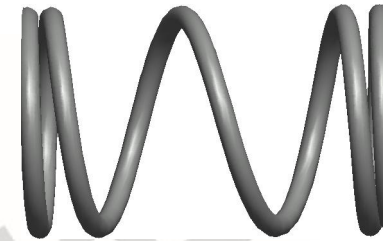

∅ 0.022
[0,56]
WIRE DIA

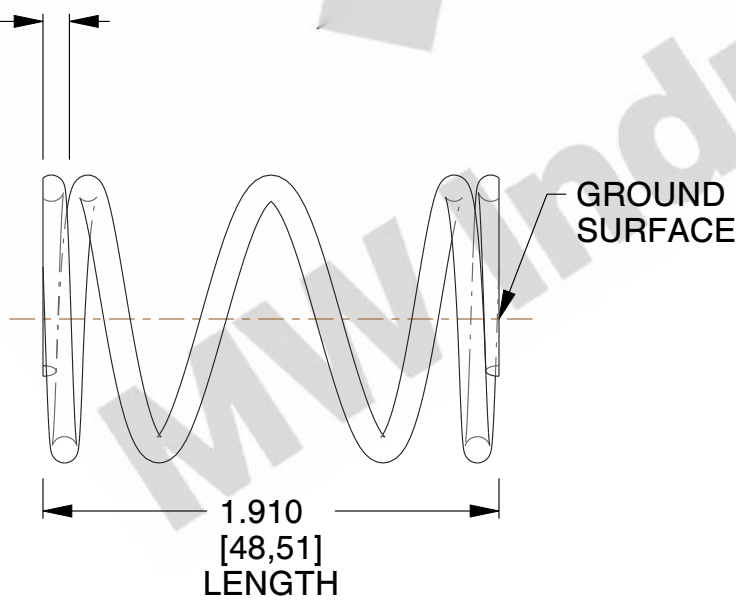

∅ 0.240
[6,10]
O.D

∅ 0.196
[4,98]
I.D

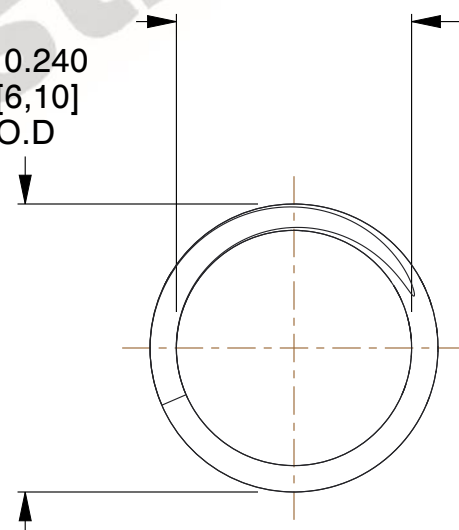

COMPONENT		SPRINGS	
70579		UNIT	
		INCH [mm]	
		SHEET	
COMPRESSION SPRINGS		1 of 1	