

NOTES:

1. Material : Spring Steel
2. Finish : Zinc - Z
3. Ends : Closed and Ground
4. Total Coils : 21.000
5. Sugg. Max. Deflection : 3.000 (in)
6. Sugg. Max. Load : 27.000 (lbs)
7. All Drawing Dimensions are in Inches [mm]

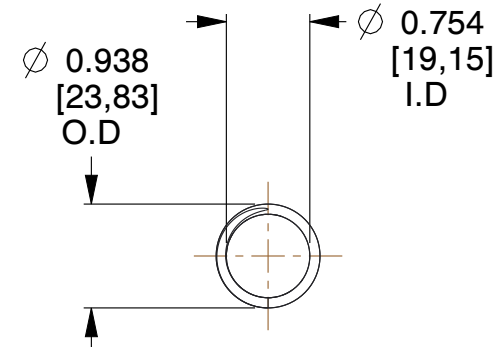
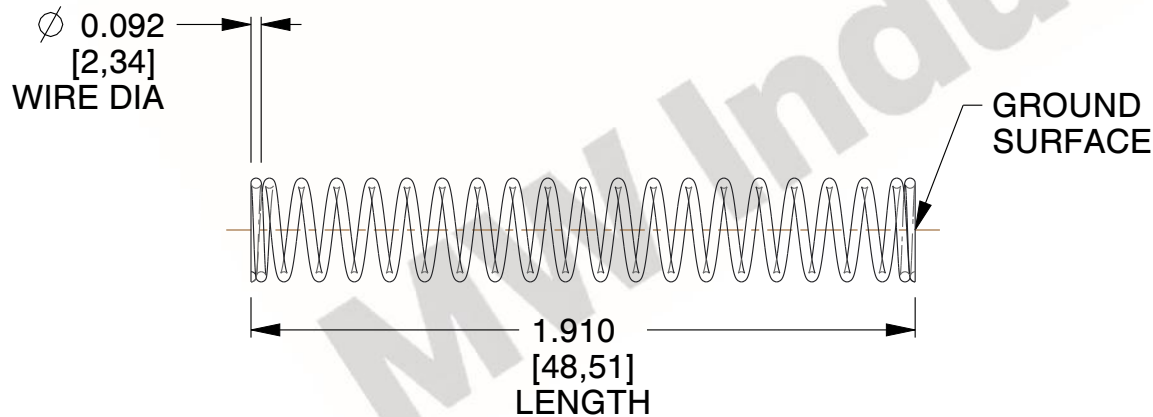

COMPONENT		SPRINGS	
4149 COMPRESSION SPRINGS		UNIT	INCH [mm]
		SHEET	1 of 1