

NOTES:

1. Material : Spring Steel
2. Finish : Zinc - Z
3. Ends : Closed and Ground
4. Total Coils : 6.000
5. Sugg. Max. Deflection : 0.220 (in)
6. Sugg. Max. Load : 49.000 (lbs)
7. All Drawing Dimensions are in Inches [mm]

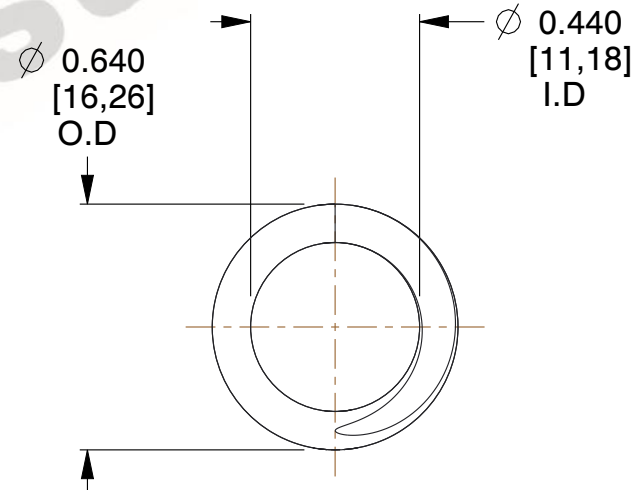
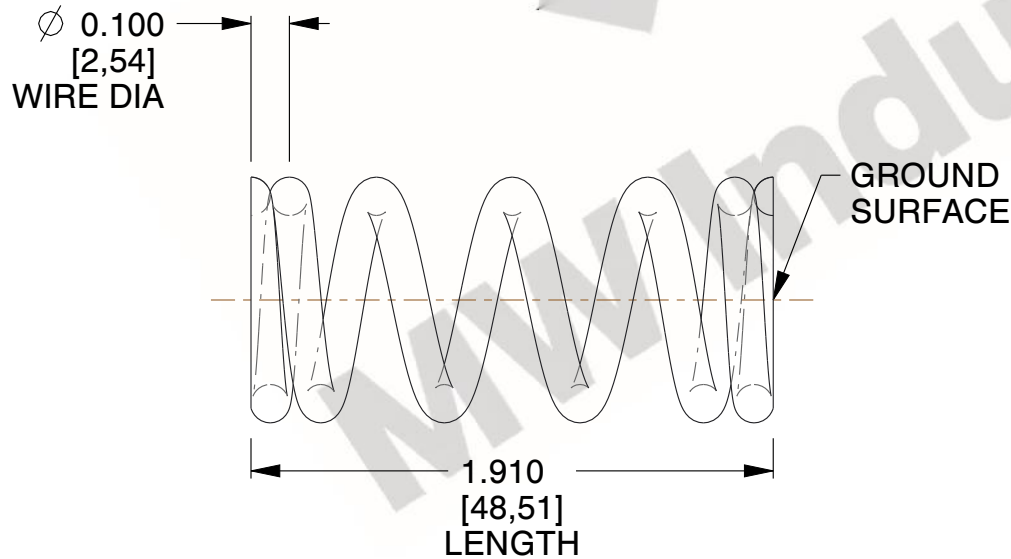
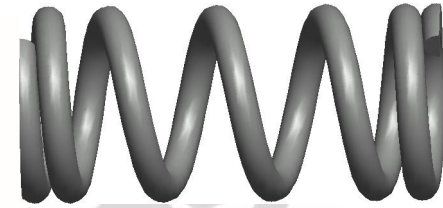

COMPONENT	SPRINGS
2705	UNIT
	INCH [mm]
	SHEET
COMPRESSION SPRINGS	1 of 1