

NOTES:

1. Material : Music Wire
2. Finish : Glod Irridite
3. Ends : Closed and Ground
4. Total Coils : 11.800
5. Sugg. Max. Deflection : 1.000 (in)
6. Sugg. Max. Load : 12.000 (lbs)
7. All Drawing Dimensions are in Inches [mm]

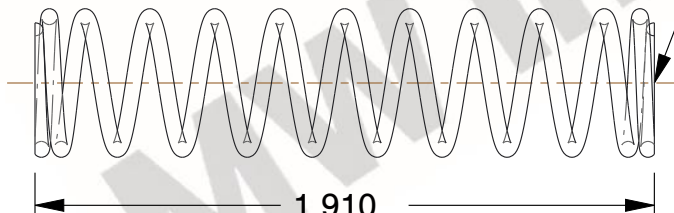

\varnothing 0.045
 [1,14]
 WIRE DIA



GROUND SURFACE

1.910
 [48,51]
 LENGTH

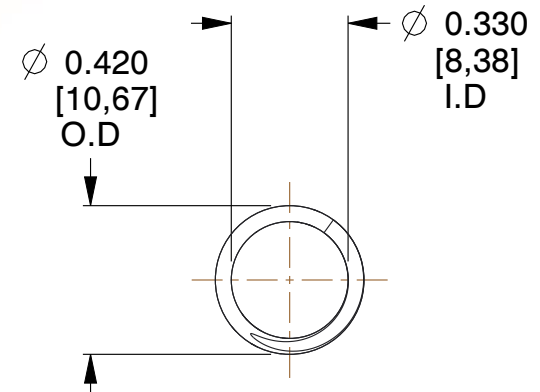

\varnothing 0.420
 [10,67]
 O.D

\varnothing 0.330
 [8,38]
 I.D

COMPONENT		SPRINGS	
71358 COMPRESSION SPRINGS		UNIT	INCH [mm]
		SHEET	1 of 1