

**NOTES:**

1. Material : Music Wire
2. Finish : Glod Irridite
3. Ends : Closed and Ground
4. Total Coils : 7.500
5. Sugg. Max. Deflection : 1.500 (in)
6. Sugg. Max. Load : 18.000 (lbs)
7. All Drawing Dimensions are in Inches [mm]

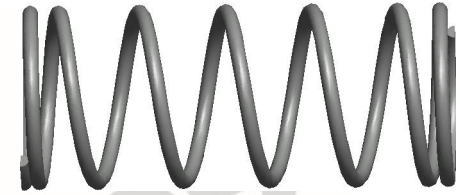

$\varnothing$  0.068  
 [1,73]  
 WIRE DIA

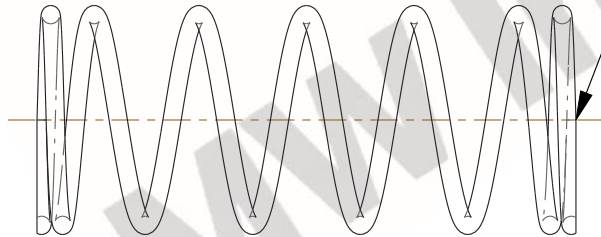

GROUND SURFACE

1.910  
 [48,51]  
 LENGTH

$\varnothing$  0.850  
 [21,59]  
 O.D

$\varnothing$  0.714  
 [18,14]  
 I.D

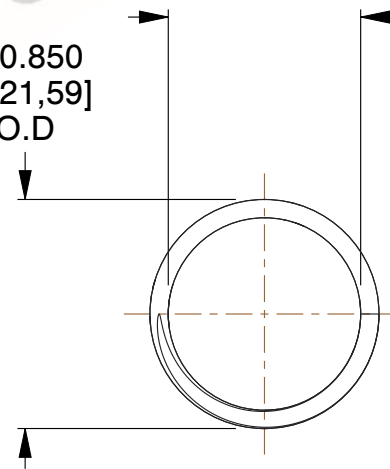

COMPONENT		SPRINGS	
<b>72178</b>  COMPRESSION SPRINGS		UNIT	INCH [mm]
		SHEET	1 of 1